



# Cambridge IGCSE™

## PHYSICS

0625/22

Paper 2 Multiple Choice (Extended)

October/November 2020

45 minutes

You must answer on the multiple choice answer sheet.

You will need: Multiple choice answer sheet  
Soft clean eraser  
Soft pencil (type B or HB is recommended)

## INSTRUCTIONS

- There are **forty** questions on this paper. Answer **all** questions.
- For each question there are four possible answers **A**, **B**, **C** and **D**. Choose the **one** you consider correct and record your choice in soft pencil on the multiple choice answer sheet.
- Follow the instructions on the multiple choice answer sheet.
- Write in soft pencil.
- Write your name, centre number and candidate number on the multiple choice answer sheet in the spaces provided unless this has been done for you.
- Do **not** use correction fluid.
- Do **not** write on any bar codes.
- You may use a calculator.
- Take the weight of 1.0 kg to be 10 N (acceleration of free fall =  $10 \text{ m/s}^2$ ).

## INFORMATION

- The total mark for this paper is 40.
- Each correct answer will score one mark. A mark will not be deducted for a wrong answer.
- Any rough working should be done on this question paper.

This document has **16** pages. Blank pages are indicated.



1 The diagram shows a measuring device.

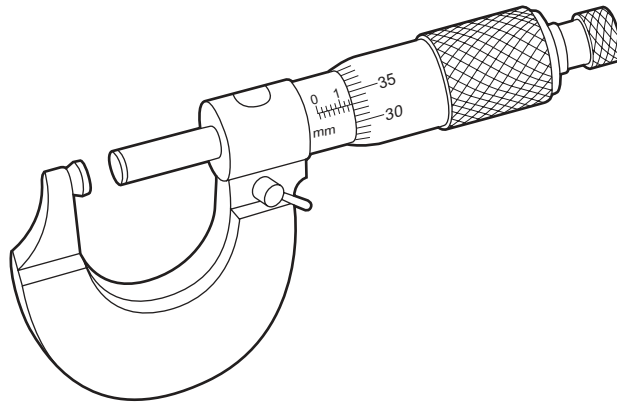

For which measurement is this device suitable?

- A diameter of a cylinder of aluminium of about 20 cm
- B distance between two molecules of zinc
- C length of a rod of iron of about 1 m
- D thickness of a sheet of copper of about 1.5 mm

2 The graph shows how the speed of an object varies with time.

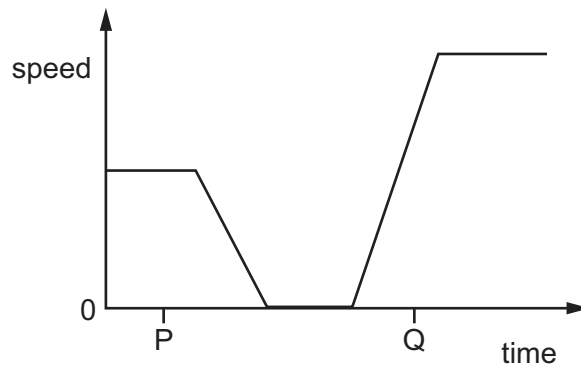

Which row describes the motion of the object at times P and Q?

	P	Q
<b>A</b>	at rest	accelerating
<b>B</b>	at rest	decelerating
<b>C</b>	moving with constant speed	accelerating
<b>D</b>	moving with constant speed	decelerating

3 A concrete block falls vertically from an aeroplane.

The concrete block falls into the sea and sinks.

Which graph shows the vertical motion of the concrete block?

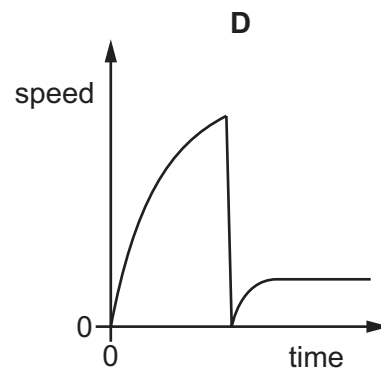
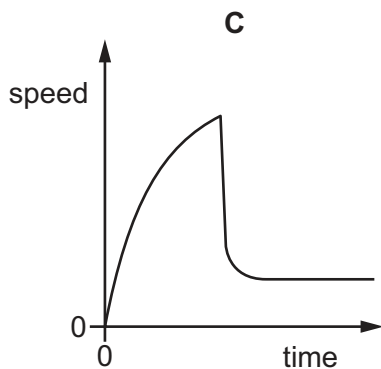
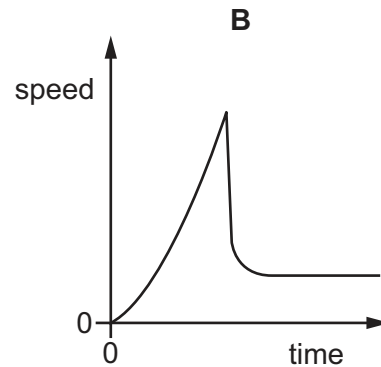
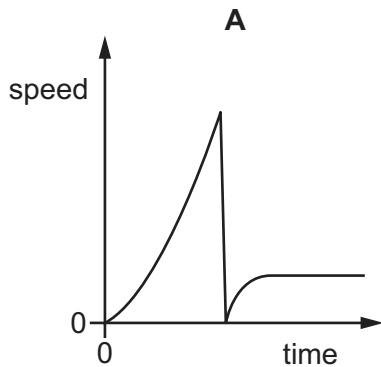

4 Which quantity is weight an example of?

- A acceleration
- B force
- C mass
- D pressure

5 Which statement about the mass of an object is correct?

- A It changes when the object is lifted further from the ground.
- B It is the gravitational force on the object.
- C It is zero if the object is in orbit around the Earth.
- D It resists any change in motion of the object.

- 6 A rectangular metal block is 20 cm long.

The cross-sectional area of the block is  $25 \text{ cm}^2$ .

The mass of the block is 4000 g.

What is the density of the metal?

- A**  $0.13 \text{ g/cm}^3$     **B**  $0.32 \text{ g/cm}^3$     **C**  $8.0 \text{ g/cm}^3$     **D**  $2000 \text{ g/cm}^3$

- 7 The diagram shows a beam lying on the ground. End Q is lifted from the ground by the force  $F$ .  
End P of the beam remains on the ground.

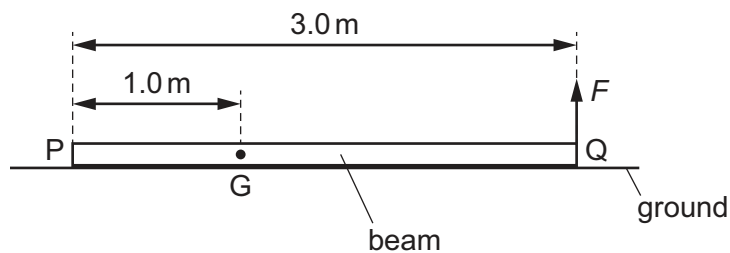

The length of the beam is 3.0 m and its weight is 600 N.

The centre of mass of the beam at G is 1.0 m from end P.

What is the size of the force  $F$  when it just raises end Q from the ground?

- A** 200 N    **B** 300 N    **C** 400 N    **D** 600 N

- 8 The diagram shows a stand. The stand holds a heavy mass above the bench.

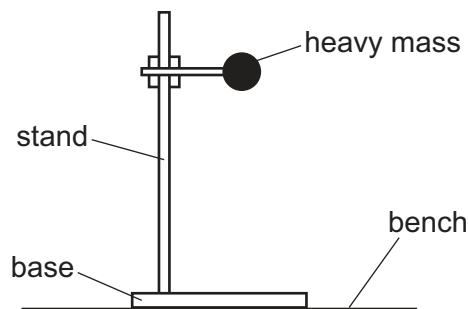

Which two changes would definitely make the stand more stable?

- A** Lower the mass and make the base narrower.  
**B** Lower the mass and make the base wider.  
**C** Raise the mass and make the base narrower.  
**D** Raise the mass and make the base wider.

- 9 A footballer kicks a stationary football.

His foot is in contact with the ball for 0.050 s.

The mass of the ball is 0.40 kg.

The speed of projection of the ball is 25 m/s.

What is the average force exerted on the ball by his foot?

- A** 0.32 N      **B** 0.50 N      **C** 200 N      **D** 1300 N

- 10 A woman of mass 50 kg has 81 J of kinetic energy.

What is her speed?

- A** 1.3 m/s      **B** 1.6 m/s      **C** 1.8 m/s      **D** 3.2 m/s

- 11 What is the source of the Sun's energy?

**A** chemical reactions in the Sun's core

**B**  $\gamma$ -emissions in the Sun's core

**C** nuclear fission in the Sun's core

**D** nuclear fusion in the Sun's core

- 12 To calculate the power produced by a force, the size of the force must be known.

What else needs to be known to calculate the power?

	the distance that the force moves the object	the time for which the force acts on the object
<b>A</b>	✓	✓
<b>B</b>	✓	x
<b>C</b>	x	✓
<b>D</b>	x	x

key

✓ = needed

x = not needed

- 13 A research submarine is at a depth of 10 000 m below the surface of the sea.

The average density of the water above the submarine is  $1030 \text{ kg/m}^3$ .

The atmospheric pressure at the surface of the sea is 103 000 Pa.

How many times greater is the pressure due to the sea water than the atmospheric pressure?

- A** 10      **B** 100      **C** 1000      **D** 100 000

14 The diagram shows a mercury barometer.

Which height is used as a measurement of atmospheric pressure?

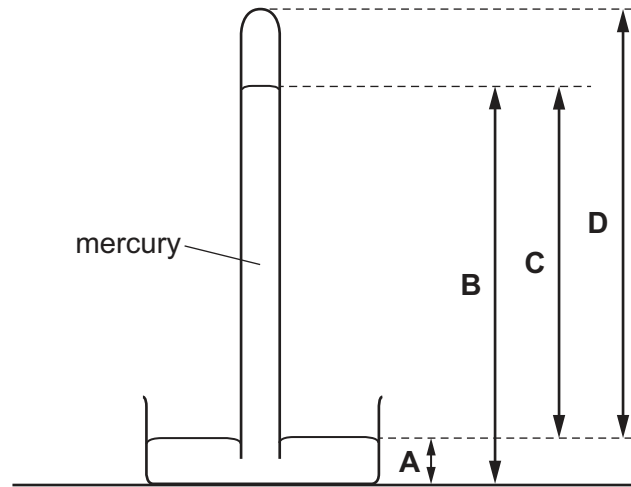

15 A student splashes water on to her face. Here are three statements about the effects.

- P The water uses energy to evaporate.
- Q The water gains energy from the student.
- R The face of the student cools.

Which statements are correct?

- A** P and Q only   **B** P and R only   **C** Q and R only   **D** P, Q and R

16 A bimetallic strip is used to control the temperature of electrical appliances. It is made of two different metals fixed together.

The diagram shows the shape of the bimetallic strip before and after heating.

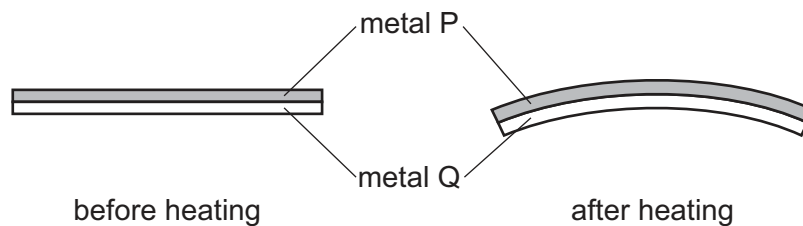

Which statement is correct?

- A** Metal P contracts more than metal Q on heating.
- B** Metal Q contracts more than metal P on heating.
- C** Metal P expands more than metal Q on heating.
- D** Metal Q expands more than metal P on heating.

17 A student writes three statements about thermocouples.

- 1 They have a small thermal capacity.
- 2 They respond very slowly to temperature changes.
- 3 They can measure temperatures above 500 °C.

Which statements are correct?

- A** 1 only      **B** 2 only      **C** 1 and 3      **D** 2 and 3

18 Four blocks are made from different metals. Each block is heated for five minutes with an identical heater.

Assume there is no energy loss from the blocks.

The table gives the masses of the blocks and the temperature rises.

Which metal has the highest specific heat capacity?

	mass of block / kg	temperature rise / °C
<b>A</b>	2.0	5.0
<b>B</b>	2.0	9.0
<b>C</b>	4.0	5.0
<b>D</b>	4.0	9.0

19 A scientist measures the air temperature at different heights from the floor in a cave. The results are recorded in the table.

height / m	temperature / °C
0	10
10	11
20	13
30	14
40	16

Why does altering the height affect the temperature of the air?

- A** The molecules in warm air have less energy than the molecules in cool air.
- B** The molecules in cool air are further apart than the molecules in warm air.
- C** Warm air is less dense than cool air.
- D** Cool air rises above warm air.

20 Four solid spheres made of the same metal are heated to the same temperature.

Which sphere initially loses thermal energy by radiation at the greatest rate?

- A diameter of 10 cm with a dull surface
- B diameter of 10 cm with a shiny surface
- C diameter of 5 cm with a dull surface
- D diameter of 5 cm with a shiny surface

21 Which row correctly describes light waves?

	wave type	direction of vibrations
<b>A</b>	longitudinal	parallel to direction of wave travel
<b>B</b>	longitudinal	perpendicular to direction of wave travel
<b>C</b>	transverse	parallel to direction of wave travel
<b>D</b>	transverse	perpendicular to direction of wave travel

22 A radio transmitter broadcasts at a frequency of 200 kHz.

What is the wavelength of these radio waves?

- A**  $6.7 \times 10^{-4}$  m    **B** 1.5 m    **C**  $1.5 \times 10^3$  m    **D**  $1.5 \times 10^6$  m



- 23** An optical lever is a very sensitive device for detecting small rotations. A lamp sends a narrow beam of light on to a small plane mirror attached to a shaft whose rotation is to be measured. The operation of the device is shown in plan view.

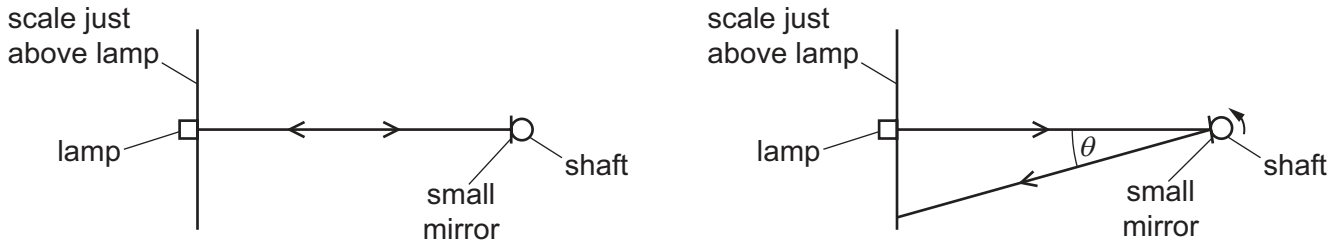

The beam from the lamp reflects from the mirror to give a small spot of light on a scale placed just above the lamp. The shaft and mirror rotate through  $1^\circ$ . The spot of light moves along the scale.

The table shows the angle  $\theta$  through which the reflected beam rotates and the conditions required for high sensitivity.

Which row is correct?

	angle $\theta$	to achieve high sensitivity
<b>A</b>	$1^\circ$	the lamp and scale need to be as close to the mirror as possible
<b>B</b>	$1^\circ$	the lamp and scale need to be as far from the mirror as possible
<b>C</b>	$2^\circ$	the lamp and scale need to be as close to the mirror as possible
<b>D</b>	$2^\circ$	the lamp and scale need to be as far from the mirror as possible

- 24** A student draws a diagram to illustrate the different sections of a longitudinal wave.

Which labelled section is a rarefaction?

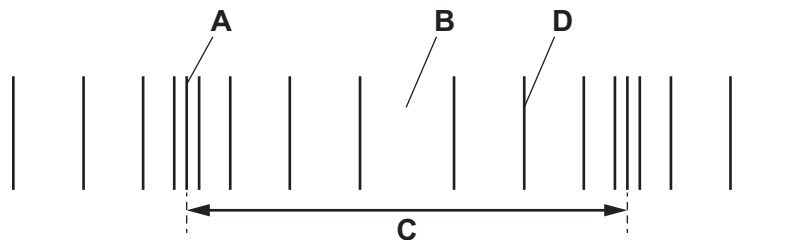

- 25 The diagram shows white light passing through a prism.

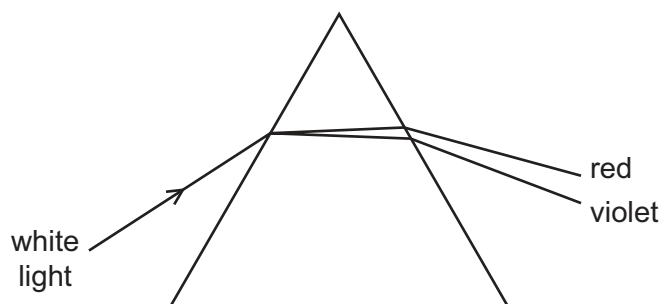

Which description of what happens as the light passes into the prism is correct?

- A** The speed of the red light is less than the speed of the violet light and the red light is the least refracted.
- B** The speed of the red light is greater than the speed of the violet light and the red light is the least refracted.
- C** The speed of the violet light is less than the speed of the red light and the violet light is the least refracted.
- D** The speed of the violet light is greater than the speed of the red light and the violet light is the least refracted.
- 26 A police car with its siren sounding is stationary in heavy traffic. A pedestrian notices that, although the loudness of the sound produced does not change, the pitch varies.

Which row describes the amplitude and the frequency of the sound?

	amplitude	frequency
<b>A</b>	constant	constant
<b>B</b>	constant	varying
<b>C</b>	varying	constant
<b>D</b>	varying	varying

- 27 A piece of steel is slightly magnetised. It is hit several times with a hammer.

What effect will this have on the steel?

	the steel is parallel to a strong magnetic field	the steel is at right-angles to a weak magnetic field
<b>A</b>	it becomes magnetised more strongly	it becomes magnetised more strongly
<b>B</b>	it becomes magnetised more strongly	it loses its magnetism
<b>C</b>	it loses its magnetism	it becomes magnetised more strongly
<b>D</b>	it loses its magnetism	it loses its magnetism

- 28 A student sets up four experiments using bar magnets and other metal objects. The N and S poles of the bar magnets are labelled N and S.

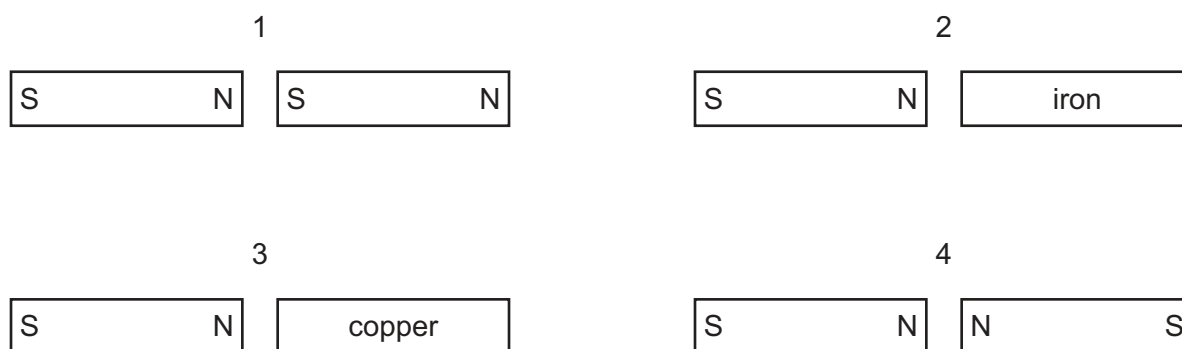

Which pairs attract each other?

- A** 1 and 2      **B** 1 and 3      **C** 2 and 4      **D** 3 and 4
- 29 Which diagram represents the strength and direction of the magnetic field around a current-carrying conductor? (The direction of the current is into the page.)

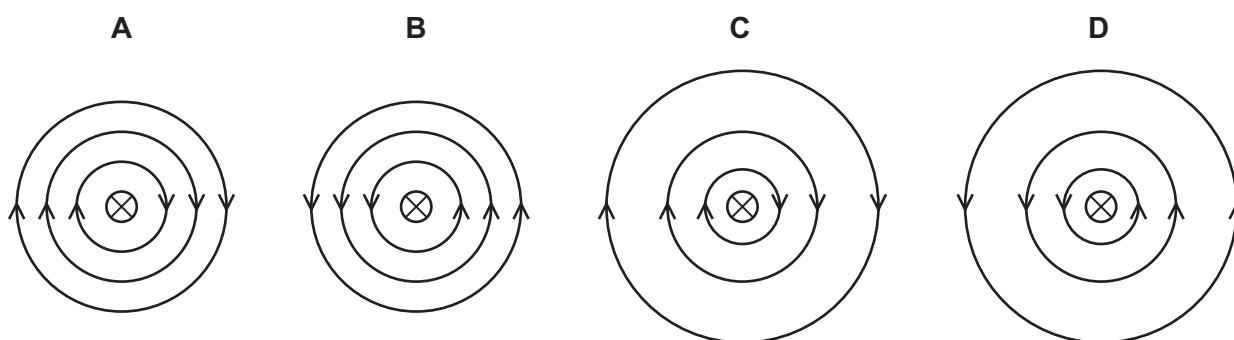

- 30 Which quantity is defined as the energy transferred by a cell in driving unit charge around a complete circuit?
- A** current  
**B** electromotive force (e.m.f.)  
**C** power  
**D** resistance
- 31 There is a current in a variable resistor when a potential difference (p.d.) is applied across it.
- In which situation is the current increased?
- A** Decrease the p.d. and keep the resistance the same.  
**B** Decrease the p.d. and increase the resistance.  
**C** Keep the p.d. the same and decrease the resistance.  
**D** Keep the p.d. the same and increase the resistance.

- 32 A student uses four ammeters P, Q, R and S to measure the current in different parts of the circuit shown.

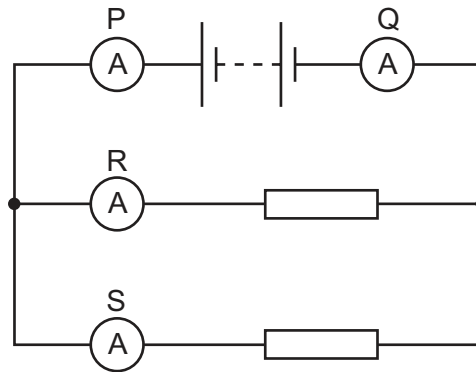

Which two ammeters read the largest current?

- A** P and Q      **B** P and R      **C** R and Q      **D** R and S
- 33 Which combination of logic gates gives the truth table shown?

inputs		output
X	Y	Z
0	0	1
0	1	1
1	0	1
1	1	0

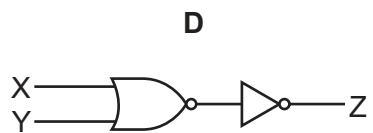
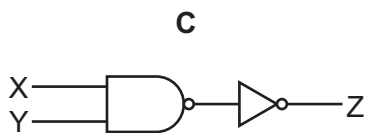
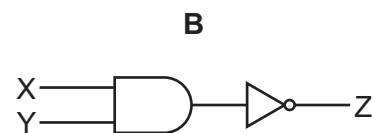
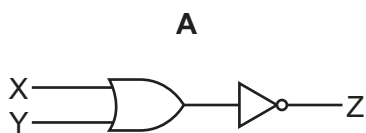

- 34 The diagram shows an a.c. generator used to power a lamp. The coil rotates in a clockwise direction.

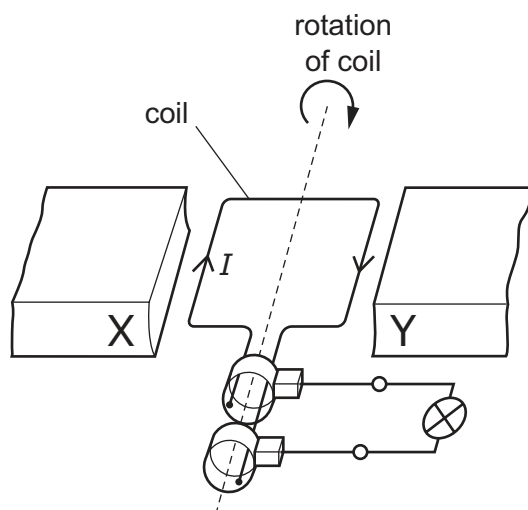

Which magnetic poles are X and Y?

	X	Y
<b>A</b>	N pole	N pole
<b>B</b>	N pole	S pole
<b>C</b>	S pole	N pole
<b>D</b>	S pole	S pole

- 35 A transformer is needed to convert a supply of 240 V a.c. into 4800 V a.c..

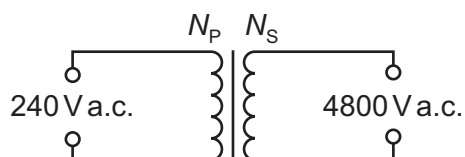

Which pair of coils would be suitable for this transformer?

	number of turns on primary coil $N_P$	number of turns on secondary coil $N_S$
<b>A</b>	50	1 000
<b>B</b>	240	48 000
<b>C</b>	480	24
<b>D</b>	2000	100

36 The diagram shows a coil of wire wrapped around a soft-iron rod.

The wire is connected to a d.c. power supply as indicated.

The apparatus is in a region which is totally shielded from the Earth's magnetic field.

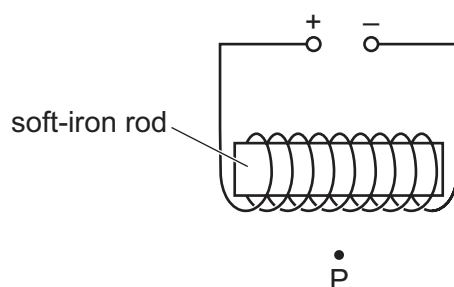

A small compass needle is placed at point P.

In which direction does the N pole of the compass needle point?

- A towards the bottom of the page
  - B towards the left of the page
  - C towards the right of the page
  - D towards the top of the page
- 37 Which statement is correct for the nucleus of **any** atom?
- A The nucleus contains electrons, neutrons and protons.
  - B The nucleus contains the same number of protons as neutrons.
  - C The nucleus has a total charge of zero.
  - D The nucleus is very small compared with the size of the atom.
- 38 The symbol represents a nucleus of zinc.



Which row gives the numbers of protons and neutrons in this nucleus?

	number of protons	number of neutrons
<b>A</b>	30	38
<b>B</b>	30	68
<b>C</b>	38	30
<b>D</b>	38	68

39 The diagram shows a beam of  $\beta$ -particles passing through a strong electric field.

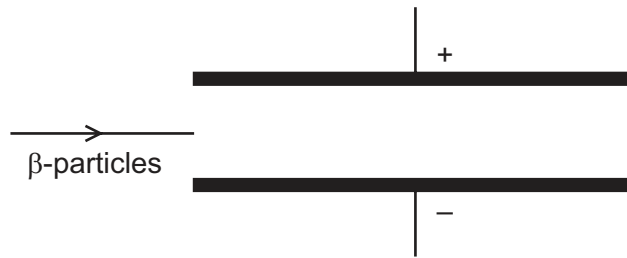

In which direction will the  $\beta$ -particles be deflected?

- A upwards towards the top of the page
- B downwards towards the bottom of the page
- C into the plane of the page
- D out of the plane of the page

40 Which equation represents the  $\beta$ -decay of lead-209?

- A  ${}_{82}^{209}\text{Pb} + {}_{-1}^0\text{e} \rightarrow {}_{83}^{209}\text{Bi}$
- B  ${}_{82}^{209}\text{Pb} + {}_{-1}^0\text{e} \rightarrow {}_{81}^{209}\text{Tl}$
- C  ${}_{82}^{209}\text{Pb} \rightarrow {}_{83}^{209}\text{Bi} + {}_{-1}^0\text{e}$
- D  ${}_{82}^{209}\text{Pb} \rightarrow {}_{81}^{209}\text{Tl} + {}_{-1}^0\text{e}$

**BLANK PAGE**

---

Permission to reproduce items where third-party owned material protected by copyright is included has been sought and cleared where possible. Every reasonable effort has been made by the publisher (UCLES) to trace copyright holders, but if any items requiring clearance have unwittingly been included, the publisher will be pleased to make amends at the earliest possible opportunity.

To avoid the issue of disclosure of answer-related information to candidates, all copyright acknowledgements are reproduced online in the Cambridge Assessment International Education Copyright Acknowledgements Booklet. This is produced for each series of examinations and is freely available to download at [www.cambridgeinternational.org](http://www.cambridgeinternational.org) after the live examination series.

Cambridge Assessment International Education is part of the Cambridge Assessment Group. Cambridge Assessment is the brand name of the University of Cambridge Local Examinations Syndicate (UCLES), which itself is a department of the University of Cambridge.